

ISTRUZIONI D'USO | INSTRUCTIONS FOR USE | GEBRAUCHSANWEISUNG |
MODE D'EMPLOI | INSTRUCCIONES DE USO

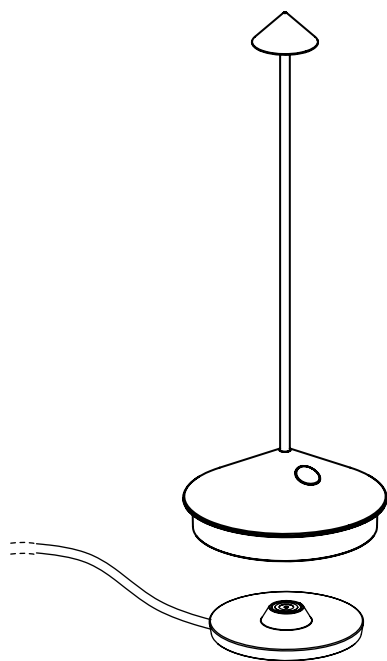

Pina Pro

lampe-à-porter

Lampada da tavolo ricaricabile | Rechargeable table lamp | Aufladbare Tischlamp
| Lampe de table rechargeable | Lámpara de mesa recargable



P 1-2



P 3-4



S 5-6



P 7-8



P 9-10



Pina Pro

Lampada da tavolo ricaricabile

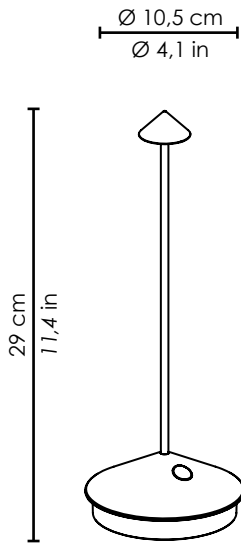

LED DIMMER | 2700 K | CRI>80 | 220-240V | IP54

LD0650B3 bianco
LD0650N3 grigio scuro
LD0650R3 corten



LED NON SOSTITUIBILE



NON INCLUSO



LD0350RP

Base di ricarica a contatto multipla (max 6 pz)

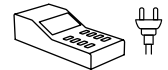

LD0340RA

Caricatore multipresa USB (8xUSB)

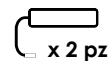

x 2 pz

BAT04703706701900

Pacco batteria sostitutiva

1. Consigli d'uso:

Questo prodotto serve esclusivamente a scopi di illuminazione e:

A) Non deve essere esposto a pesanti carichi meccanici o forti contaminazioni; B) può essere installato e usato solo previo controllo delle condizioni del prodotto; verificare che non risulti sporco e non abbia subito danneggiamenti durante lo stoccaggio; C) l'installazione e la manutenzione vanno eseguite ad apparecchio spento; D) modifiche o manomissioni del prodotto e il non rispetto delle indicazioni riportate possono rendere l'apparecchio pericoloso; E) i prodotti con grado di protezione 54 (IP54) sono idonei per uso esterno; F) per la pulizia di tutte le superfici metalliche e plastiche utilizzare un panno morbido asciutto; G) la ditta Zafferano declina ogni responsabilità per danni causati da un proprio prodotto montato in modo non conforme alle istruzioni.

2. Dati tecnici:

- Potenza: 2,2 W
- Volt: DC 5 V
- Flusso luminoso: 185 lm
- Pacco batteria al litio inclusa: 18650/2200mAh*1x2 ; per le istruzioni di sostituzione del pacco batteria consultare il sito web www.zafferanoitalia.com; si raccomanda di usare batterie originali per la sostituzione.
- Ricarica: 6-8 h
- Durata batteria: 13 h
- Classe: III
- Grado di protezione: IP54
- CRI>80

3. Carica batterie:

- Base di ricarica singola: INPUT AC100-240V 50/60Hz; OUTPUT 5V - 1A; USB line 1.2 m
- Base di ricarica multipla: INPUT AC100-240V 50/60Hz; OUTPUT 5V- 1A; USB line 1.2 m
- La lampada funziona correttamente anche se collegata alla corrente
- Si raccomanda l'utilizzo del caricatore e della base di ricarica originale. In alternativa utilizzare un caricatore a 1A certificato

4. Attenzione:

- Il piano d'appoggio della lampada non deve superare i 15° di inclinazione o rischia la caduta
- La batteria ha la funzione di protezione da sovraccarico
- Per preservare l'integrità della batteria si consiglia di mantenere la carica tra il 20% minimo e 80% massimo; se la lampada non viene utilizzata per lunghi periodi, si consiglia di procedere periodicamente ad un ciclo di carica/scarica del prodotto
- Si prega di fare riferimento alle leggi locali per un corretto smaltimento e riciclaggio della batteria

ISTRUZIONI D'USO



ACCENSIONE

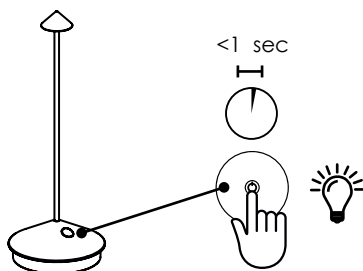

Rapido tocco sul touch per accendere la lampada

SPEGNIMENTO

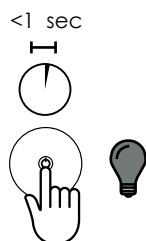

Rapido tocco sul touch per spegnere la lampada

DIMMERAZIONE

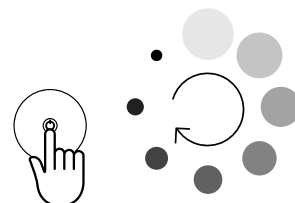

A lampada accesa, leggera pressione sul touch fino al raggiungimento della luminosità desiderata
Ad ogni accensione, l'intensità luminosa torna al 100%

RICARICA

Effettuare una carica completa della batteria prima del primo utilizzo.
Per un corretto caricamento della lampada si consiglia di:

- 1) collegare il cavo USB al caricatore;
- 2) collegare la spina alla presa elettrica;
- 3) appoggiare la lampada sulla base di ricarica;
- 4) a carica completata scollegare la spina dalla presa elettrica e rimuovere il cavo USB

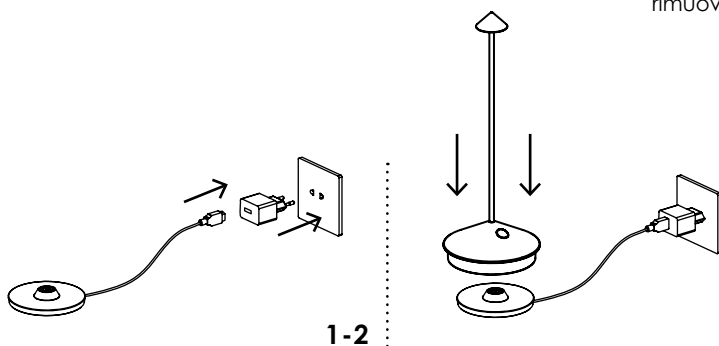

LED DI SEGNALAZIONE

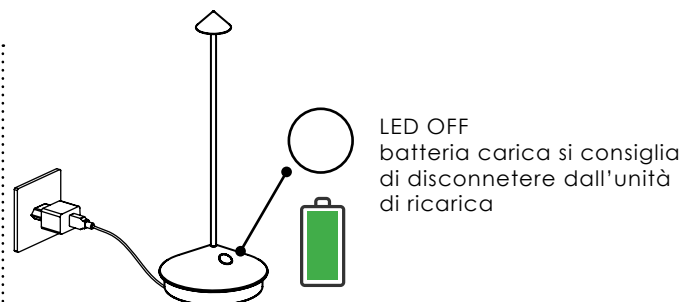
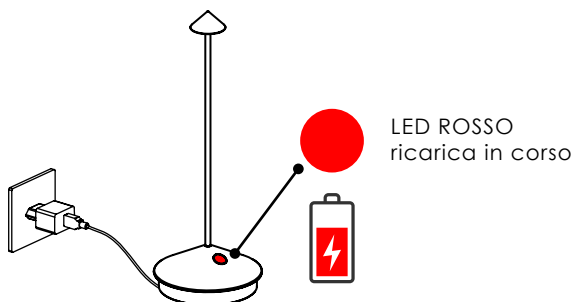



Pina Pro

Rechargeable table lamp

Ø 10,5 cm
Ø 4,1 in

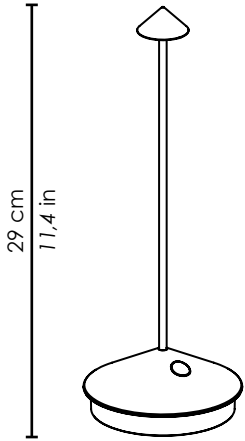

LED DIMMER | 2700 K | CRI>80 | 220-240V | IP54

LD0650B3 white
LD0650N3 dark grey
LD0650R3 rust

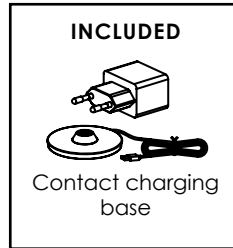

NON-REPLACEABLE LED



NOT INCLUDED

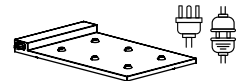

LD0350RP
Multi-contact
charging base
(max. 6 pc)

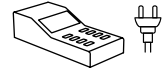

LD0340RA
Multi-socket USB
charger (8xUSB)

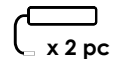

BAT04701906701900
Replacement
battery pack

1. Tips for use:

This product is exclusively for lighting purposes and:

A) It must not be exposed to heavy mechanical loads or contamination; B) It can be installed and used only after checking the state of the product; check that it is not dirty and has not been damaged during storage; C) Installation and maintenance must be carried out when the appliance is switched off; D) Any alterations to the product, any tampering and any failure to comply with the instructions provided may make the appliance hazardous; E) Products with IP54 protection are suitable for outdoor use; F) All metal and plastic surfaces should be cleaned with a soft dry cloth; G) The company Zafferano shall not be held liable for any damage caused due to its products being assembled in any manner that does not comply with the instructions provided.

2. Technical data:

- Power: 2,2 W
- Volt: DC 5 V
- Lumen lamp: 185 lm
- Lithium battery pack included: 18650/2200mAh*1x2; for instructions about how to replace the battery pack, please consult the website: www.zafferanoitalia.com. We recommend using an original battery pack as a replacement.
- Charge: 6-8 h
- Battery life: 13 h
- Class: III
- Protection rating: IP54
- CRI>80

3. Charger:

- Contact charging base: INPUT AC100-240V 50/60Hz; OUTPUT 5V- 1A; USB line 1.2 m
- Multi-contact charging base: INPUT AC100-240V 50/60Hz; OUTPUT 5V- 1A; USB line 1.2 m
- The lamp also operates properly when connected to the mains power supply
- It is advisable to use the original charger and charging base. Alternatively, you can use a certified 1A charger

4. Important:

- The support surface for the lamp must not exceed a 15° tilt or it will fall.
- The battery has an overload protection function.
- To preserve the integrity of the battery, we recommend keeping the charge between minimum 20% and maximum 80%; if the lamp is not used for long periods, it is advisable to regularly charge/discharge the product.
- Please refer to local laws for the proper disposal and recycling of the battery.

INSTRUCTIONS FOR USE



SWITCHING ON

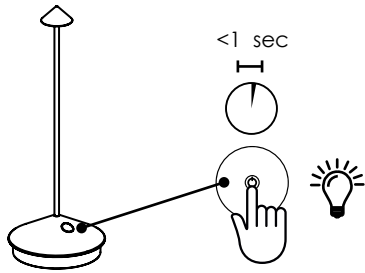

Quickly press the touch sensor to switch on the lamp

SWITCHING OFF

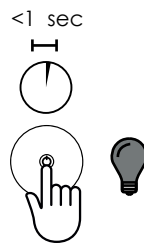

Quickly press the touch sensor to switch off the lamp

DIMMER FUNCTION

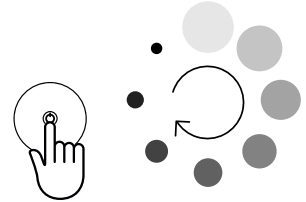

When the lamp is switched on, lightly press the touch sensor to obtain the desired brightness. Every time you turn it on, the light intensity returns to 100%

CHARGE

Charge the battery before initial use.

To correctly charge the lamp, we recommend that you:

- 1) Connect the USB cable to the adaptor;
- 2) Put the plug into the electrical socket;
- 3) Place the lamp on the charging base;
- 4) When fully charged, disconnect the plug from the electrical socket

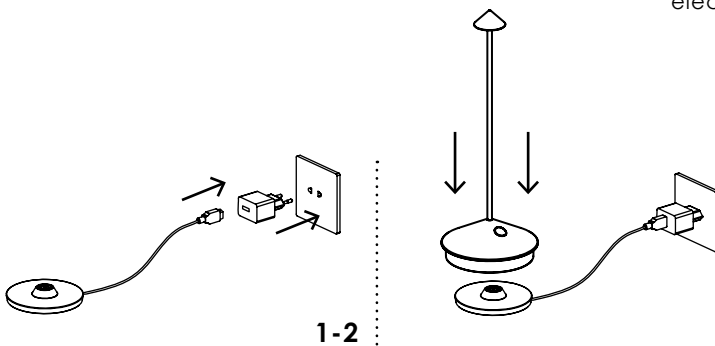

INDICATOR LEDS

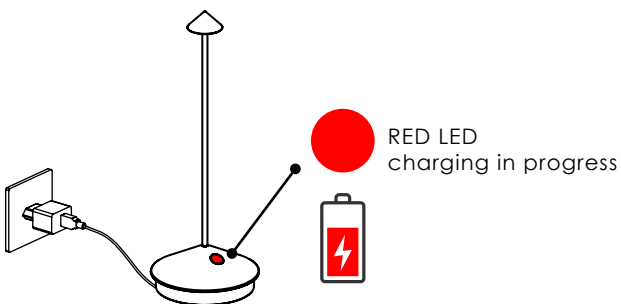

RED LED
charging in progress

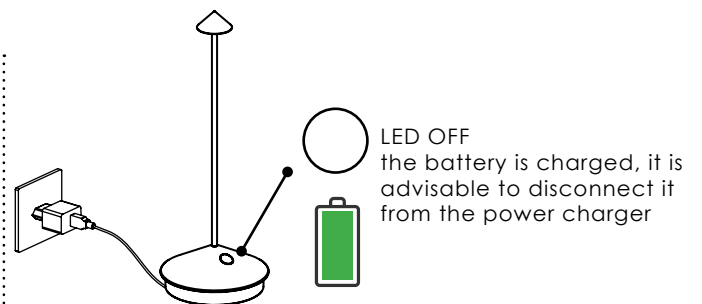

LED OFF
the battery is charged, it is
advisable to disconnect it
from the power charger



Pina Pro

aufladbare Tischlampe

Ø 10,5 cm
Ø 4,1 in

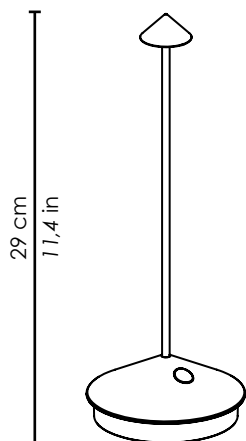

LED DIMMER | 2700 K | CRI>80 | 220-240V | IP54

LD0650B3 weiss
LD0650N3 dunkelgrau
LD0650R3 corten

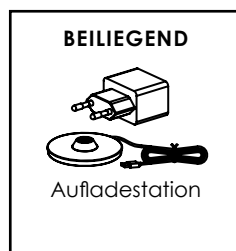

Aufladestation

LED NICHT AUSTAUSCHBAR



NICHT ENTHALTEN



LD0350RP
Aufladestation für
mehrere Geräte
(max. 6)



LD0340RA
Ladegerät (8xUSB)



x 2 st

BAT04701906701900
Ersatzakku

1. Hinweise zur Verwendung:

Dieses Produkt dient ausschließlich zur Beleuchtung und:

A) Darf keinen starken mechanischen Belastungen oder starken Kontaminationen ausgesetzt werden; B) kann nur, nachdem der Zustand des Produkts kontrolliert wurde, installiert und verwendet werden; prüfen, dass es nicht schmutzig ist und während der Lagerung nicht beschädigt wurde; C) Das Gerät muss ausgeschaltet, installiert oder gewartet werden; D) Durch die Veränderung oder Manipulation des Produkts und die Nichteinhaltung dieser Anweisungen kann das Gerät gefährlich werden; E) Produkte mit Schutzgrad 54 (IP54) können im Freien verwendet werden; F) Zur Reinigung aller Metall- oder Plastikoberflächen ein trockenes, weiches Tuch verwenden; G) Die Firma Zafferano lehnt jede Verantwortung für Schäden ab, die durch eines ihrer Produkte, das nicht gemäß der gelieferten Anweisungen montiert wurde, entstehen.

2. Technische Daten:

- Leistung: 2,2 W
- Volt: DC 5 V
- Absoluter Lichtstrom: 185 lm
- Eine Lithiumbatterie ist in der Lieferung enthalten: 18650/2200mAh*1x2 ; zu den Anweisungen zum Auswechseln der Batterie schauen Sie bitte auf die Webseite www.zafferanoitalia.com. Die Batterie sollte nur durch eine Originalbatterie ersetzt werden.
- Aufladezeit: 6-8 h
- Batteriedauer: 13 h
- Klasse: III
- Schutzgrad: IP54
- CRI>80

3. Ladegerät:

- Aufladestation: INPUT AC100-240V 50/60Hz; OUTPUT 5V- 1A; USB line 1.2 m
- Aufladestation für mehrere Geräte: INPUT AC100-240V 50/60Hz; OUTPUT 5V - 1A; USB line 1.2 m
- Die Lampe funktioniert auch mit Stromanschluss korrekt
- Wir raten dazu, das mitgelieferte Original-Aufladegerät und die Original-Aufladestation zu verwenden. Als Alternative ein zertifiziertes 1A-Aufladegerät verwenden.

4. Achtung:

- Die Standfläche der Lampe darf keine höhere Neigung als 15° besitzen, sonst fällt diese um.
- Die Batterie sorgt dem Überlastungsschutz.
- Um die Lebensdauer des Akkus zu erhalten, sollte sein Ladestand zwischen 20 und 80 Prozent liegen. Wenn die Lampe lange Zeit nicht benutzt wird, sollte der Akku regelmäßig ent- und wieder aufgeladen werden.
- Die Batterie muss entsprechend der geltenden, lokalen Vorschriften zur Abfallentsorgung und -wiederverwertung behandelt werden.

GEBRAUCHSANWEISUNG



EINSCHALTEN

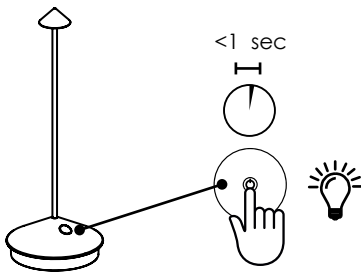

Die Taste kurz drücken und die Lampe geht an

AUSSCHALTEN

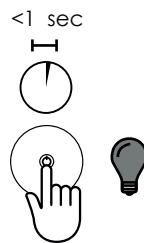

Die Taste kurz drücken und die Lampe geht aus

LICHT DIMMEN

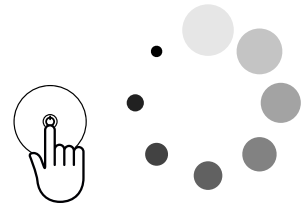

Wenn die Lampe an ist, leicht auf den Taster drücken, bis die gewünschte Helligkeit erreicht wurde. Sobald das Gerät erneut eingeschaltet wird, ist die Lichtstärke wieder 100%.

AUFLADEN

Die Batterie des Produkts vor dem ersten Gebrauch vollkommen aufladen.

Um die Lampe korrekt aufzuladen, sollte man:

- 1) Das USB-Kabel an den Adapter anschließen;
- 2) Den Stecker in die Steckdose stecken;
- 3) Die Lampe auf die Aufladestation stellen;
- 4) Wenn die Lampe aufgeladen ist, den Stecker aus der Steckdose ziehen und das USB-Kabel von der Lampe trennen

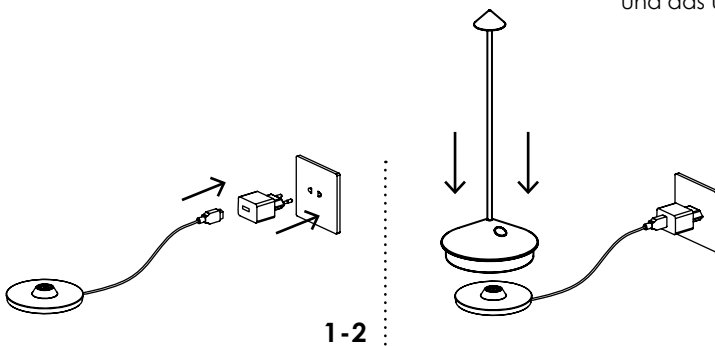

LEDANZEIGE

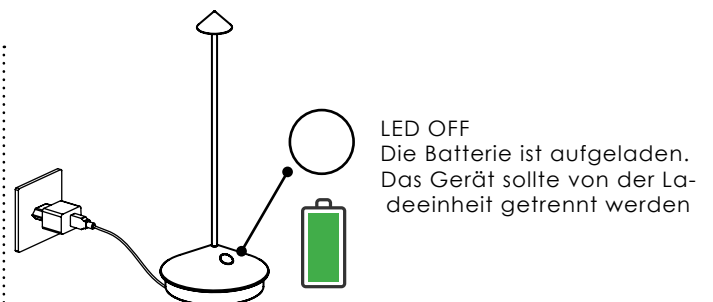
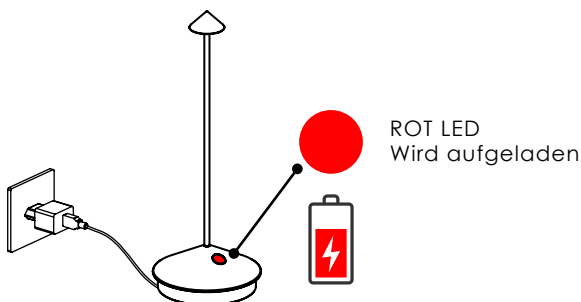



Pina Pro

Lampe de table rechargeable

Ø 10,5 cm
Ø 4,1 in

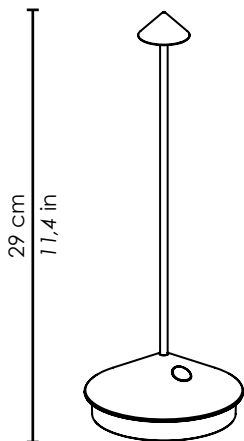

LED DIMMER | 2700 K | CRI>80 | 220-240V | IP54

LD0650B3 blanc
LD0650N3 gris foncé
LD0650R3 corten

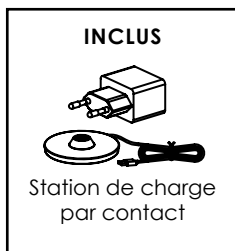

LED NON REMPLAÇABLE



NON INCLUS



LD0350RP

Station de charge par contact multiple (max. 6 pcs)

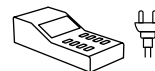

LD0340RA

Station de charge multiple (8xUSB)



x 2 pc

BAT04701906701900

Batterie de remplacement

1. Conseils d'utilisation:

Ce produit sert exclusivement pour éclairer et:

A) Ne doit pas être exposé à de lourdes charges mécaniques ou à de fortes contaminations; B) Peut être installé et utilisé uniquement après avoir contrôlé les conditions du produit; vérifier s'il n'est pas sale et s'il n'a pas subi de dommages durant le stockage; C) L'installation et l'entretien doivent être effectués lorsque l'appareil est éteint; D) Les modifications ou les altérations du produit et le non-respect des indications fournies peuvent rendre l'appareil dangereux; E) Les produits avec un degré de protection 54 (IP54) sont adaptés pour une utilisation extérieure; F) Pour le nettoyage de toutes les surfaces métalliques et plastiques, utiliser un chiffon souple et sec; G) La société Zafferano décline toute responsabilité pour les dommages provoqués par un produit monté de manière non conforme par rapport aux instructions.

2. Données techniques:

- Puissance: 2,2 W
- Voltage: DC 5 V
- Flux lumineux: 185 lm
- Batteries au lithium inclus: 18650/2200mAh*1x2; visiter le site www.zafferanoitalia.com pour avoir les indications de son remplacement. Pour le remplacement, il est recommandé l'usage d'un assemblage-batteries original.
- Recharge: 6-8 h
- Durée de la batterie: 13 h
- Classe: III
- Degré de protection: IP54
- CRI>80

3. Chargeur de batterie:

- Station de charge par contact: INPUT AC100-240V 50/60Hz; OUTPUT 5V- 1A; USB line 1.2 m
- Station de charge par contact multiple: INPUT AC100-240V 50/60Hz; OUTPUT 5V- 1A; USB line 1.2 m
- La lampe fonctionne correctement, même si elle est raccordée au courant
- Il est conseillé d'utiliser le chargeur et la station de charge d'origine. En alternative, utiliser un chargeur à 1A certifié.

4. Attention:

- Le plan d'appui de la lampe ne doit pas dépasser 15° d'inclinaison, sinon elle risque de tomber
- La batterie est munie de la fonction de protection contre les surcharges
- Pour préserver l'intégrité de la batterie, il est conseillé de maintenir la charge entre 20% minimum et 80% maximum; si la lampe n'est pas utilisée pendant de longues périodes, il est conseillé de procéder périodiquement à un cycle de charge/décharge du produit
- Se référer aux lois locales pour une élimination correcte et le recyclage de la batterie

MODE D'EMPLOI



ALLUMAGE

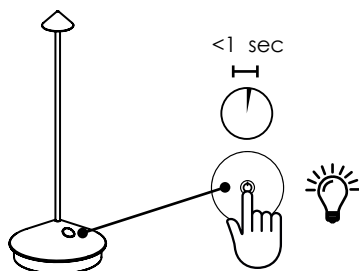

Pression rapide sur le touch pour allumer la lampe

COUPURE

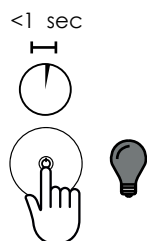

Pression rapide sur le touch pour éteindre la lampe

VARIATION DE L'INTENSITE LUMINEUSE

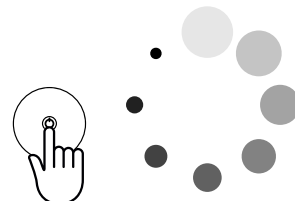

Lorsque la lampe est allumée, appuyer légèrement sur le touch tant que la luminosité désirée n'est pas atteinte. Lors de chaque allumage, l'intensité lumineuse est réglée à 100%

RECHARGE

Recharger complètement la batterie avant la première utilisation. Pour recharger la lampe correctement, il est conseillé de:

- 1) brancher le câble USB à l'adaptateur;
- 2) insérer la fiche dans la prise de courant;
- 3) placer la lampe sur la station de charge;
- 4) lorsque la lampe est rechargée, retirer la fiche de la prise de courant et enlever le câble USB

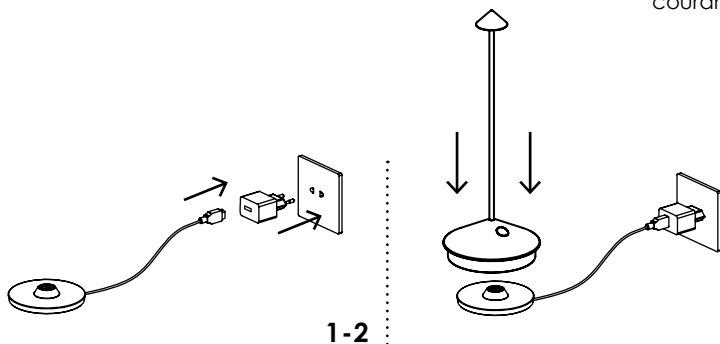

LED DE SIGNALISATION

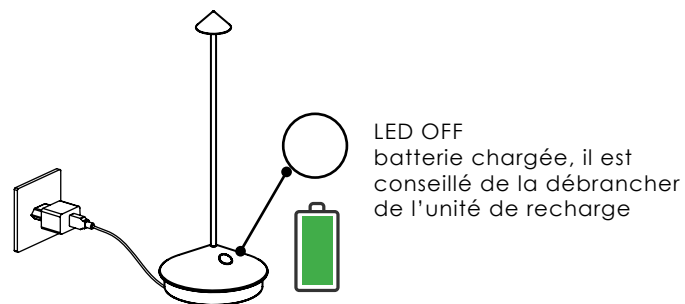
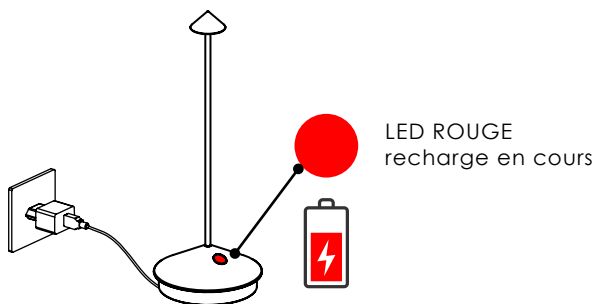



Pina Pro

Lámpara de mesa recargable

Ø 10,5 cm
Ø 4,1 in

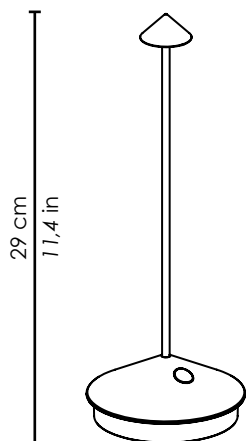

LED DIMMER | 2700 K | CRI>80 | 220-240V | IP54

LD0650B3 blanco
LD0650N3 gris oscuro
LD0650R3 corten



LED NO REEMPLAZABLE



NO INCLUIDO



LD0350RP

Base de recarga con contacto múltiple (máx. 6 piezas)



LD0340RA

Cargador múltiple USB (8xUSB)



x 2 pc

BAT04701906701900

Paquete batería sustitutiva

1. Consejos de uso:

Este producto debe utilizarse exclusivamente para iluminación y:

A) No debe ser expuesto a cargas mecánicas pesadas o contaminaciones fuertes; B) solo puede ser instalado y utilizado previo control de las condiciones del producto; verificar que no resulte estar sucio y no ha haya sido dañado durante el almacenamiento; C) la instalación y el mantenimiento deben realizarse con el aparato apagado; D) las modificaciones o las manipulaciones del producto y el incumplimiento de las indicaciones mostradas pueden hacer que el aparato sea peligroso; E) los productos con grado de protección 54 (IP54) son idóneos para uso en exteriores; F) para la limpieza de todas las superficies metálicas y de plástico utilizar un paño suave y seco; G) La empresa Zafferano declina cualquier responsabilidad por los daños causados por un producto suyo montado de manera no conforme con las instrucciones.

2. Datos técnicos:

- Potencia: 2,2 W
- Voltios: DC 5 V
- Flujo luminoso: 185 lm
- Batería de litio incluida: 18650/2200mAh*1x2; para las instrucciones de sustitución de la batería consulte el sitio web www.zafferanoitalia.com. Para la sustitución se recomienda el uso de una batería original.
- Recarga: 6-8 h
- Duración de la batería: 13 h
- Clase: III
- Grado de protección: IP54
- CRI>80

3. Cargador de baterías:

- Base de recarga con contacto: INPUT AC100-240V 50/60Hz; OUTPUT 5V- 1A; USB line 1.2 m
- Base de recarga con contacto múltiple: INPUT AC100-240V 50/60Hz; OUTPUT 5V- 1A; USB line 1.2 m
- La lámpara funciona correctamente, aunque esté conectada a la corriente
- Se recomienda el uso del cargador y de la base de recarga original. Alternativamente utilizar un cargador de 1A certificado

4. Atención:

- La superficie de apoyo de la lámpara no debe superar los 15° de inclinación para evitar su caída
- La batería tiene la función de protección ante sobrecargas
- Para preservar la integridad de la batería se aconseja mantener la carga entre un mínimo del 20% y un máximo del 80%; si la lámpara no se utiliza durante periodos prolongados se aconseja realizar periódicamente un ciclo de carga/descarga del producto
- Remítase a las normativas de ley locales para una eliminación y reciclaje correctos de la batería

INSTRUCCIONES DE USO



ENCENDIDO

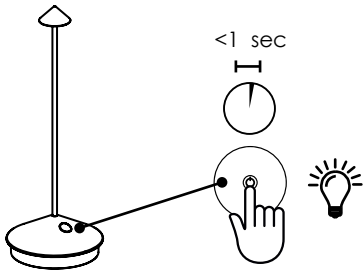

Toque rápido en la pantalla táctil para encender la lámpara

APAGADO

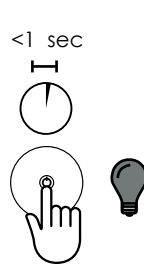

Toque rápido en la pantalla táctil para apagar la lámpara

OSCURECIMIENTO

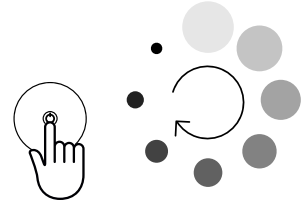

Con la lámpara encendida, apretar ligeramente en la pantalla táctil hasta lograr el brillo deseado. En cada encendido la intensidad luminosa vuelve al 100%

RECARGA

Realizar una carga completa de la batería antes de usarla por primera vez.

Para una carga correcta de la lámpara se aconseja:

- 1) conecte el cable USB al cargador;
- 2) conecte el enchufe a la toma de corriente;
- 3) apoyar la lámpara en la base de recarga;
- 4) una vez completada la carga, retire el enchufe de la toma eléctrica y retire el cable.

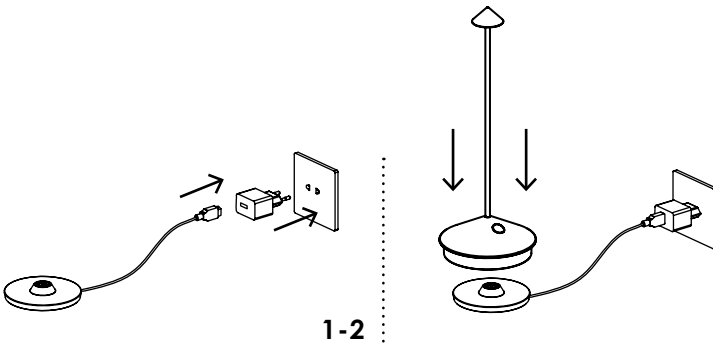

LED DE SEÑALIZACIÓN

