

# COSMIC

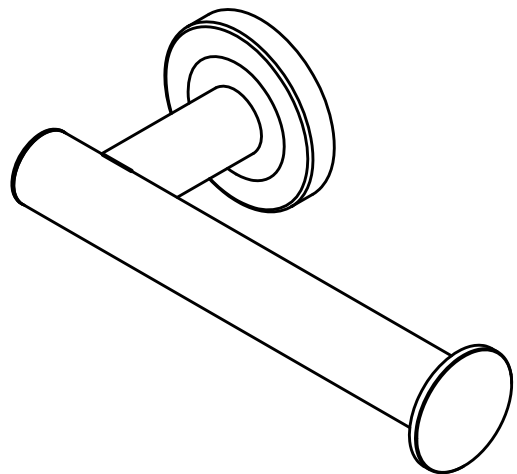
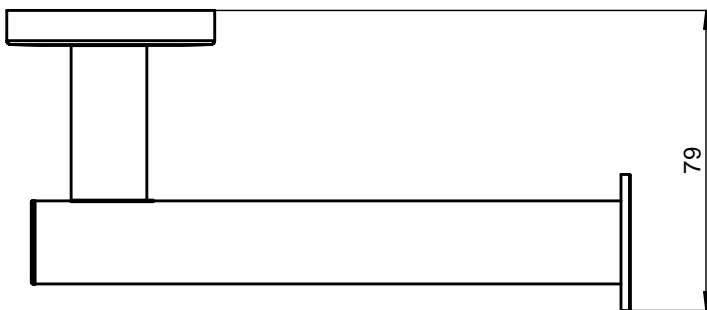
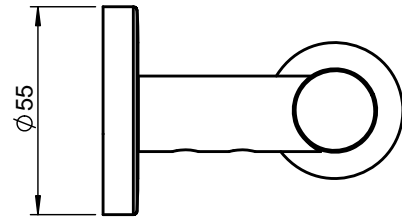
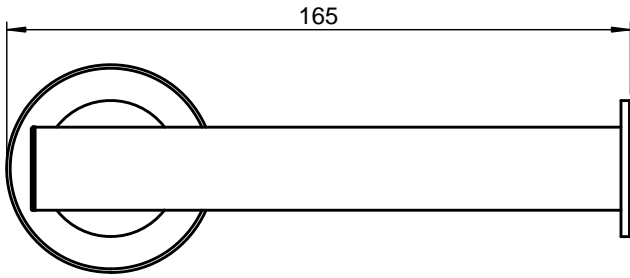

ARCHITECT S+	Ref.	235##58EW	
PAPER HOLDER WITHOUT COVER	SCALE	<b>1:2</b>	DIMENSION-MM
Este plano es propiedad de Industrias Cosmic, S.A., en términos legales no puede ser publicado ni reproducido sin su autorización escrita. This drawing belongs to Industrias Cosmic S.A. In legal terms, it may neither be published nor reproduced without its written authorisation.			