

Washtop without / with cut out

40511.0

40511.1



TECHNICAL DATA

| | | | |
|------------------------|--|----------------------|--|
| Order no. | 40511.0 / without cut out 40511.1 / 1 cut out | Mounting information | The walls installed on must meet the requirements of the furniture in terms of weight and the supplied fastening elements. If this cannot be guaranteed another method of installation needs to be chosen. |
| Dimensions (WxHxD) | 596 x 80 x 520 mm | | |
| Matching for washbasin | see matrix for washtops 596 mm | Colours body | 463 – White 519 – Chalked oak 548 – Anthracite oak |
| Specification | Body – MDF board with PVC foil without or with cut out with 2 mounting brackets max. load 150 kg | | |
| Weight | 10,5 kg | | |
| Accessories excl. | For possible drawer elements Case see matrix. Towel rail, chromed, order no. 49095.2 | | |
| Mounting acc. incl. | Installation set, order no. 49012.4 and mounting brackets | | |

TECHNICAL DRAWINGS / S 1 : 20

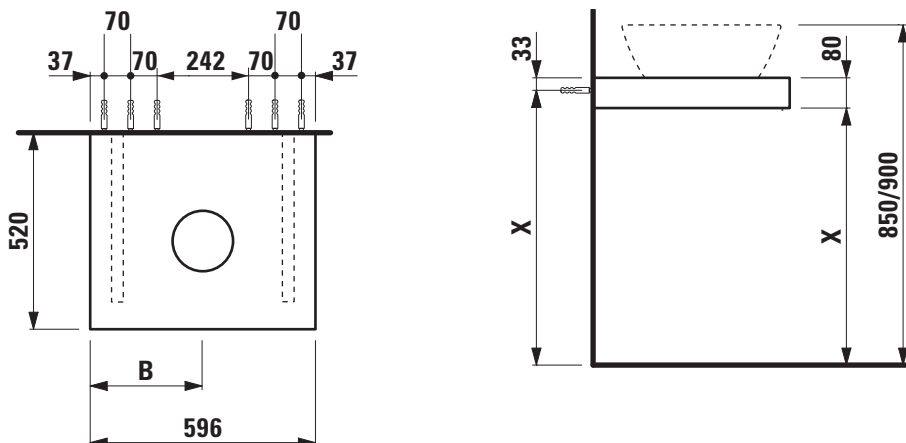





| | |
|--------|---|
| B / mm | Ceramic |
| 210 | Palomba s1680.2 |
| 298 | all other from matrix for washtops Case |



X = The exact height must be set during installation.

Matrix for washtops 596 mm / 791 mm / 894 mm without and with drawer elements

POSSIBLE COMBINATIONS WITH WASHBASINS KARTELL BY LAUFEN, LAUFEN PRO S, LAUFEN PRO



| Washtop 596 mm |  |  |
|--------------------------|---|---|
| Ceramic | | |
| Kartell by Laufen | | |
| ø1233.1 420x420 mm | ✓ | ✓ |
| ø1233.2 750x350 mm | | |
| Laufen Pro S | | |
| ø1696.1 450x340 mm | ✓ | ✓ |
| ø1696.2 550x465 mm | | |
| ø1696.3 600x465 mm | | |
| ø1696.4 650x465 mm | | |
| ø1696.5 850x460 mm | | |
| ø1696.6 1050x460 mm | | |
| ø1696.7 700x465 mm | | |
| ø1896.3 560x440 mm | | |
| Laufen Pro | | |
| ø1195.2 450x340 mm | ✓ | ✓ |
| ø1295.2 550x380 mm | ✓ | ✓ |
| ø1295.3 600x380 mm | | |
| ø1295.6 850x485 mm | | |
| ø1295.8 1050x485 mm | | |
| ø1296.2 420x420 mm | ✓ | ✓ |
| ø1296.4 520x390 mm | ✓ | ✓ |
| ø1395.1 560x440 mm | | |
| ø1396.1 560x440 mm | | |
| ø1695.2 600x400 mm | | |
| ø1795.1 550x480 mm | | |
| ø1795.2 600x480 mm | | |
| ø1795.3 650x480 mm | | |



| Washtop 791 mm |  |  |
|--------------------------|---|--|
| Ceramic | | |
| Kartell by Laufen | | |
| ø1233.1 420x420 mm | ✓ | ✓ |
| ø1233.2 750x350 mm | | |
| Laufen Pro S | | |
| ø1696.1 450x340 mm | ✓ | ✓ |
| ø1696.2 550x465 mm | ✓ | ✓ |
| ø1696.3 600x465 mm | ✓ | ✓ |
| ø1696.4 650x465 mm | ✓ | ✓ |
| ø1696.5 850x460 mm | | |
| ø1696.6 1050x460 mm | | |
| ø1696.7 700x465 mm | | |
| ø1896.3 560x440 mm | ✓ | |
| Laufen Pro | | |
| ø1195.2 450x340 mm | ✓ | ✓ |
| ø1295.2 550x380 mm | ✓ | ✓ |
| ø1295.3 600x380 mm | ✓ | ✓ |
| ø1295.6 850x485 mm | | |
| ø1295.8 1050x485 mm | | |
| ø1296.2 420x420 mm | ✓ | ✓ |
| ø1296.4 520x390 mm | ✓ | ✓ |
| ø1395.1 560x440 mm | ✓ | |
| ø1396.1 560x440 mm | ✓ | |
| ø1695.2 600x400 mm | ✓ | ✓ |
| ø1795.1 550x480 mm | ✓ | ✓ |
| ø1795.2 600x480 mm | ✓ | ✓ |
| ø1795.3 650x480 mm | ✓ | ✓ |



| Washtop 894 mm |  |  |
|--------------------------|---|---|
| Ceramic | | |
| Kartell by Laufen | | |
| ø1233.1 420x420 mm | ✓ | ✓ |
| ø1233.2 750x350 mm | ✓ | ✓ |
| Laufen Pro S | | |
| ø1696.1 450x340 mm | ✓ | ✓ |
| ø1696.2 550x465 mm | ✓ | ✓ |
| ø1696.3 600x465 mm | ✓ | ✓ |
| ø1696.4 650x465 mm | ✓ | ✓ |
| ø1696.5 850x460 mm | | |
| ø1696.6 1050x460 mm | | |
| ø1696.7 700x465 mm | ✓ | ✓ |
| ø1896.3 560x440 mm | ✓ | |
| Laufen Pro | | |
| ø1195.2 450x340 mm | ✓ | ✓ |
| ø1295.2 550x380 mm | ✓ | ✓ |
| ø1295.3 600x380 mm | ✓ | ✓ |
| ø1295.6 850x485 mm | | |
| ø1295.8 1050x485 mm | | |
| ø1296.2 420x420 mm | ✓ | ✓ |
| ø1296.4 520x390 mm | ✓ | ✓ |
| ø1395.1 560x440 mm | ✓ | |
| ø1396.1 560x440 mm | ✓ | |
| ø1695.2 600x400 mm | ✓ | ✓ |
| ø1795.1 550x480 mm | ✓ | ✓ |
| ø1795.2 600x480 mm | ✓ | ✓ |
| ø1795.3 650x480 mm | ✓ | ✓ |

Matrix for washtops 596 mm / 791 mm / 894 mm without and with drawer elements

POSSIBLE COMBINATIONS WITH WASHBASINS LIVING CITY, LIVING SQUARE, PALOMBA COLLECTION

| Washtop 596 mm |  |  |
|---------------------------|---|---|
| Ceramic | | |
| Living City | | |
| ø1143.0 450x380 mm | ✓ | ✓ |
| ø1143.1 500x425 mm | ✓ | ✓ |
| ø1143.2 600x425 mm | | |
| ø1743.2 500x460 mm | ✓ | ✓ |
| ø1743.4 600x460 mm | | |
| ø1743.7 800x470 mm | | |
| ø1843.8 1000x470 mm | | |
| Living Square | | |
| ø1143.3 360x360 mm | ✓ | ✓ |
| ø1143.4 600x340 mm | | |
| ø1143.5 380x380 mm | ✓ | ✓ |
| ø1543.5 500x380 mm | | |
| ø1643.2 650x480 mm | | |
| ø1643.4 900x480 mm | | |
| Palomba Collection | | |
| ø1180.1 450x450 mm | ✓ | ✓ |
| ø1280.1 510x510 mm | ✓ | ✓ |
| ø1680.1 900x420 mm | | |
| ø1680.2 520x380 mm | ✓ | ✓ |
| ø1680.3 600x400 mm | | |

| Washtop 791 mm |  |  |
|---------------------------|---|--|
| Ceramic | | |
| Living City | | |
| ø1143.0 450x380 mm | ✓ | ✓ |
| ø1143.1 500x425 mm | ✓ | ✓ |
| ø1143.2 600x425 mm | ✓ | ✓ |
| ø1743.2 500x460 mm | ✓ | ✓ |
| ø1743.4 600x460 mm | ✓ | ✓ |
| ø1743.7 800x470 mm | | |
| ø1843.8 1000x470 mm | | |
| Living Square | | |
| ø1143.3 360x360 mm | ✓ | ✓ |
| ø1143.4 600x340 mm | ✓ | ✓ |
| ø1143.5 380x380 mm | ✓ | ✓ |
| ø1543.5 500x380 mm | ✓ | |
| ø1643.2 650x480 mm | ✓ | |
| ø1643.4 900x480 mm | | |
| Palomba Collection | | |
| ø1180.1 450x450 mm | ✓ | ✓ |
| ø1280.1 510x510 mm | ✓ | ✓ |
| ø1680.1 900x420 mm | | |
| ø1680.2 520x380 mm | ✓ | ✓ |
| ø1680.3 600x400 mm | ✓ | ✓ |

| Washtop 894 mm |  |  |
|---------------------------|---|---|
| Ceramic | | |
| Living City | | |
| ø1143.0 450x380 mm | ✓ | ✓ |
| ø1143.1 500x425 mm | ✓ | ✓ |
| ø1143.2 600x425 mm | ✓ | ✓ |
| ø1743.2 500x460 mm | ✓ | ✓ |
| ø1743.4 600x460 mm | ✓ | ✓ |
| ø1743.7 800x470 mm | ✓ | ✓ |
| ø1843.8 1000x470 mm | | |
| Living Square | | |
| ø1143.3 360x360 mm | ✓ | ✓ |
| ø1143.4 600x340 mm | ✓ | ✓ |
| ø1143.5 380x380 mm | ✓ | ✓ |
| ø1543.5 500x380 mm | ✓ | |
| ø1643.2 650x480 mm | ✓ | |
| ø1643.4 900x480 mm | | |
| Palomba Collection | | |
| ø1180.1 450x450 mm | ✓ | ✓ |
| ø1280.1 510x510 mm | ✓ | ✓ |
| ø1680.1 900x420 mm | ✓ | ✓ |
| ø1680.2 520x380 mm | ✓ | ✓ |
| ø1680.3 600x400 mm | ✓ | ✓ |