









MLN Linea / 6220
Stefan Kärhs

AL
 ▧ 610 x 200 | H 66
 2 x G5 |  24 W.
 ⊕ |  |  |  | EEI: A

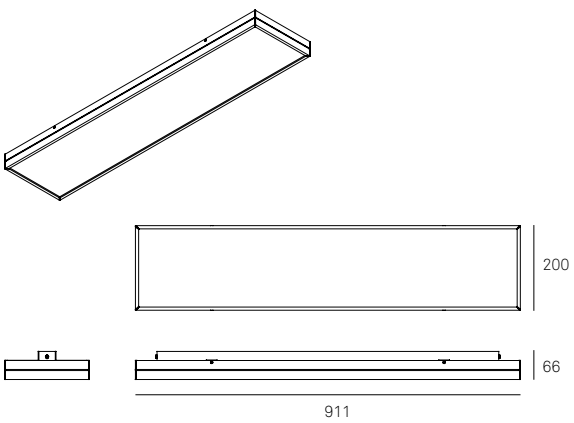

MLN Linea / 6222
Stefan Kärhs

AL
 ▧ 911 x 200 | H 66
 2 x G5 |  39 W.
 ⊕ |  |  |  | EEI: A

