

Aufputz-Montage  
Pose en applique  
Surface mounting

AP

ARA/SP	A	B
50	35	(7.5)
60	35	(12.5)
70	55	(7.5)
80	55	(12.5)
90	65	(12.5)

ARA/SP	A	B
100	65	(17.5)
120	95	(12.5)
130	95	(17.5)
150	125	(12.5)

LED  
4000K

LED  
Optional  
3000K

IP 24

	160.250; 251	160.260; 261	160.270; 271
	ARA/SP 50/LED; /SD	ARA/SP 60/LED; /SD	ARA/SP 70/LED; /SD
	1 x 10W/1200 lm + 1 x 10W/1200 lm	1 x 12W/1500 lm + 1 x 12W/1500 lm	1 x 15W/1900 lm + 1 x 15W/1900 lm
A	50	60	70
B	47.2	57.2	67.2

	160.280; 281	160.290; 291	160.300; 301
	ARA/SP 80/LED; /SD	ARA/SP 90/LED; /SD	ARA/SP 100/LED; /SD
	1 x 17W/2200 lm + 1 x 17W/2200 lm	1 x 20W/2450 lm + 1 x 20W/2450 lm	1 x 22W/2750 lm + 1 x 22W/2750 lm
A	80	90	100
B	77.2	87.2	97.2

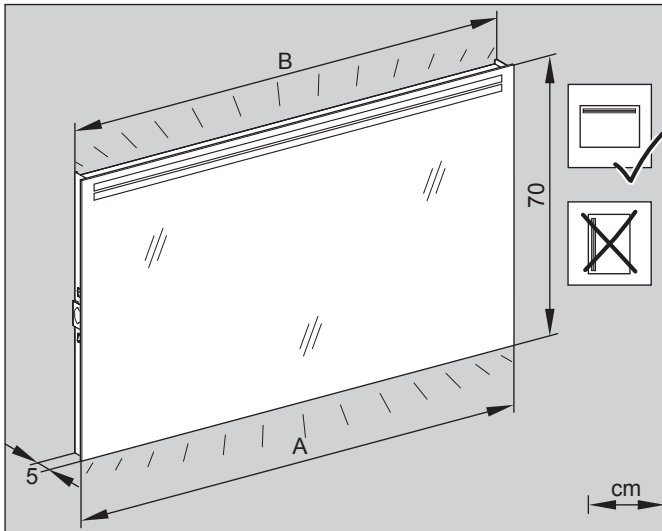

	160.320; 321	160.330; 331	160.350; 351
	ARA/SP 120/LED; /SD	ARA/SP 130/LED; /SD	ARA/SP 150/LED; /SD
	1 x 27W/3400 lm + 1 x 27W/3400 lm	1 x 29W/3700 lm + 1 x 29W/3700 lm	1 x 34W/4250 lm + 1 x 34W/4250 lm
A	120	130	150
B	117.2	127.2	147.2

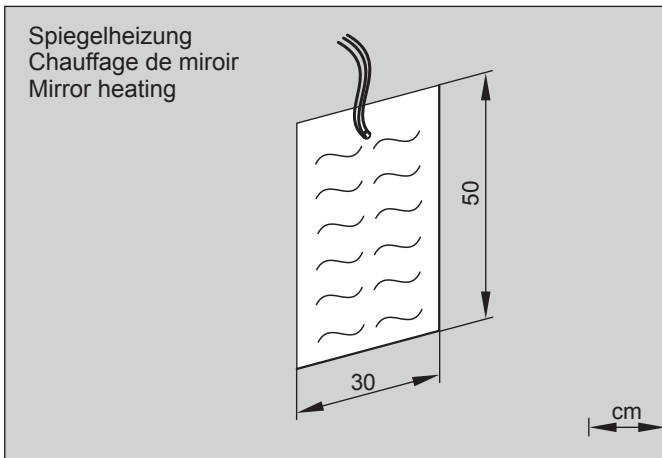

	160.901	160.902	160.903
	SH/L	SH/M	SH/R
	20W	20W	20W

Position auf dem Spiegel / je nach Breite mit 1 bis 3 Stück (160.901-903)  
Position sur le miroir / selon largeur disponible avec 1 à 3 unités (160.901-903)  
Position on the mirror / can be ordered with 1 to 3 units (160.901-903)

ARA/SP 50/60/70

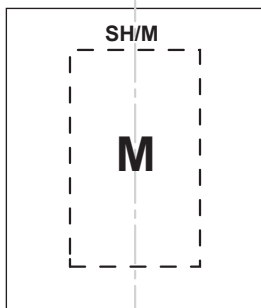

ARA/SP 80/90/100

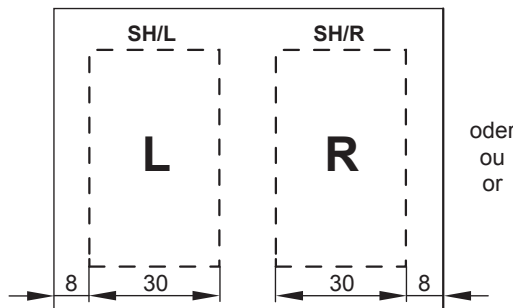

ARA/SP 80/90/100

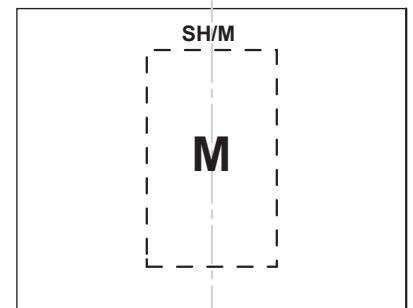

ARA/SP 120/130/150

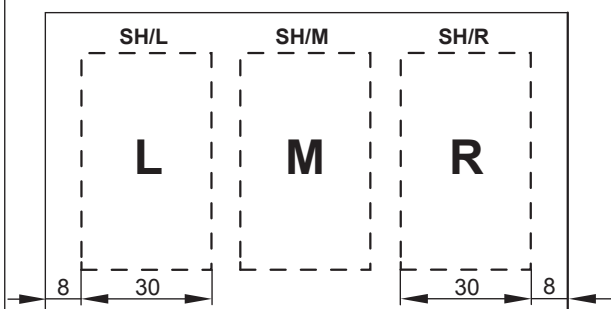



Rahmen in der Montage um 180° drehbar.  
 Cadre pivotant de 180° lors du montage.  
 Frame can be rotated by 180° during assembly.

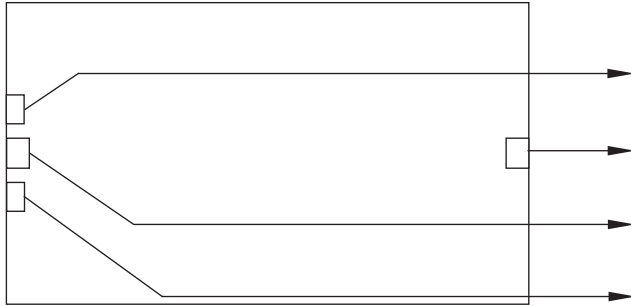
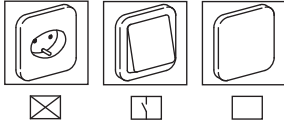

CH		DE		GB
/SD		/SD		

Mit Spiegelheizung  
 Avec chauffage de miroir  
 With mirror heating

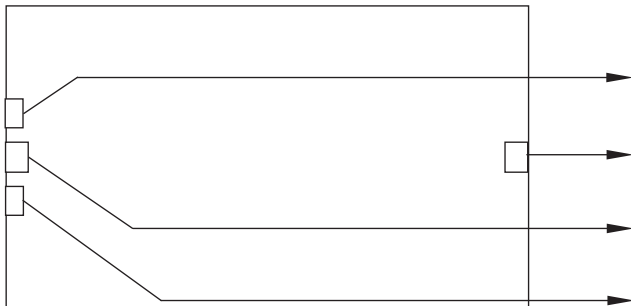

CH		DE		GB
/SD		/SD		

Arbeiten an den elektrischen Anlagen dürfen nur von autorisierten Fachleuten nach den örtlichen Vorschriften ausgeführt werden.

Les travaux à l'installation électrique ne doivent être effectués que par des spécialistes autorisés selon les prescriptions locales.

Electric installation work may only be carried out by approved specialists according to the local regulations.



Genauere Angaben über Ausführung und Ausrüstung entnehmen Sie der entsprechenden Preis- und Typenliste. Änderungen vorbehalten.

Veuillez prendre de plus amples information en ce qui concerne l'équipement de notre liste des prix et des modèles correspondante. Sous réserve de modifications.

For further information as equipment details please refer to our corresponding price and model list. Alterations are reserved.